

use & care guide

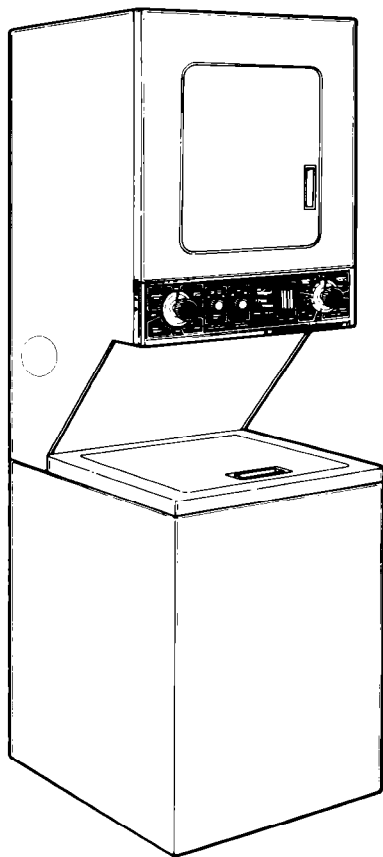

thin
twin

WASHER • DRYER

**Models LT5000XM
LT5004XM
LT5008XM**

Wave Ovens, Trash Compactors, Room Air Conditioners, Dehumidifiers, Automatic Washers, Clothes Dryers, Freezers, Refrigerator-Freezers

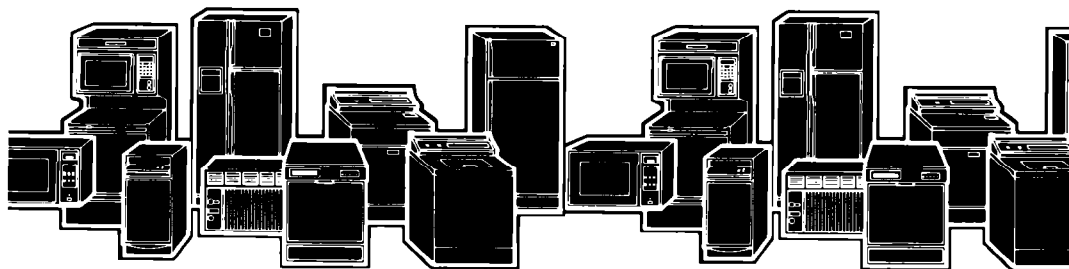

Parts and features

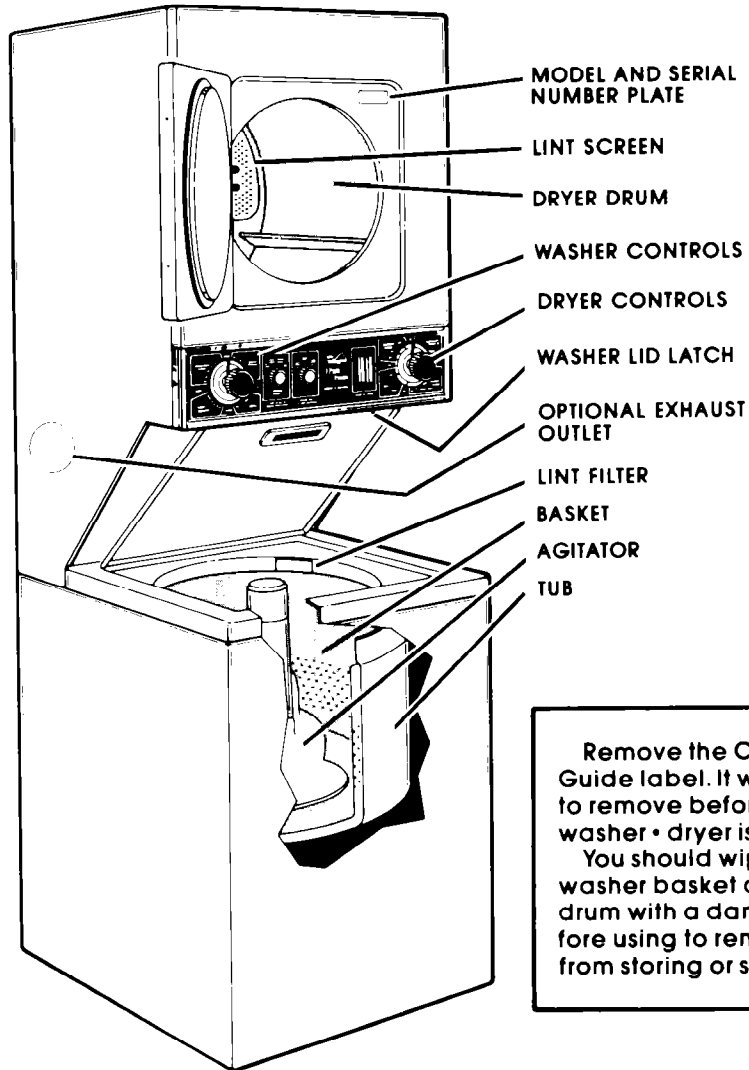

Remove the Consumer Buy Guide label. It will be easier to remove before the washer • dryer is used.

You should wipe out the washer basket and dryer drum with a damp cloth before using to remove dust from storing or shipping.

Copy your Model and Serial Numbers here

When you need service or call with a question, have this information ready:

1. **Complete** Model and Serial Numbers (from the plate located as shown).
2. Purchase date from sales slip.

Copy this information in these spaces. Keep this book, your warranty and sales slip together in a handy place. There is no warranty registration to return. Proof-of-purchase is all that is required for in-warranty service.

Complete Model Number

Complete Serial Number

Purchase Date

Service Company and
Telephone Number

Contents

Your Responsibilities	3	Operating Instructions	12
Installation	3	Selecting a Cycle	13
Operation	3	Drying Tips	14
Safety	4	Lint Screen	15
Before Using Your Washer • Dryer	5	Lint Removal	15
WASHER		WASHER • DRYER	
Starting Your Washer	6	Vacation Care	16
Lid Latch	7	Winterizing	16
What Happens in Each Cycle ..	8	If You Need Service or	
Other Operating Instructions ..	10	Assistance	17
Cleaning the Lint Filter	10	1. Before Calling for	
DRYER		Assistance	17
Starting Your Dryer	11	2. If You Need Assistance	18
		3. If You Need Service	18
		4. If You Have a Problem	18

©1984 Whirlpool Corporation

Your responsibilities

Read this "Use and Care Guide" and your "Laundry Guide" carefully for important use and safety information.

You are personally responsible for installation. Have your washer / dryer installed by a qualified installer and make sure that it has been ...

1. Installed exactly according to the "Installation Instructions," including ...

- proper electrical supply, outlet and grounding;*
- proper water supply, plumbing fixtures and drain;*
- proper dryer exhausting system.*

2. Installed and leveled in a room where ...

- there is adequate ventilation and protection from weather;
- the floor is strong enough to support the weight;
- The temperature is above 45° F (7.2° C) because ...
 - the dryer will not operate properly at cold temperatures.
 - freezing temperatures can damage the washer.

*Refer to the "Installation Instructions" for complete information.

You are personally responsible for proper use of your washer / dryer. You must be sure that it is ...

1. Used only by those who understand how to operate it properly.
2. Properly maintained and used only for jobs expected of home washers and dryers.

You are personally responsible for the safe use of your washer / dryer.

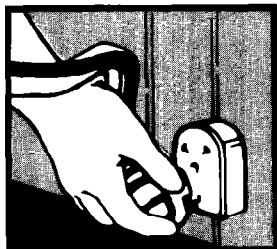

DO NOT try to service this appliance unless it is unplugged or the electrical power has been turned off.

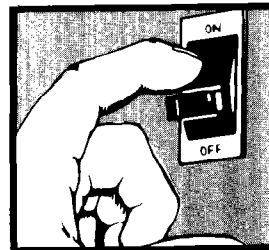

POISON GAS can be formed if chlorine bleach is used in the same wash as ammonia or acids such as vinegar or rust remover.

• FOR YOUR SAFETY •
DO NOT STORE OR USE GASOLINE OR OTHER FLAMMABLE VAPORS AND LIQUIDS IN THE VICINITY OF THIS OR ANY OTHER APPLIANCE.

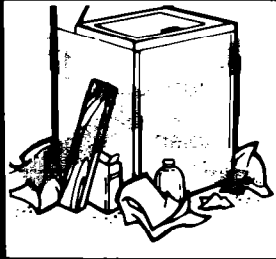

DO NOT let dust, lint, paper, rags, chemicals, etc., pile up around or under the appliance. **DO NOT** install the appliance against drapes or curtains.

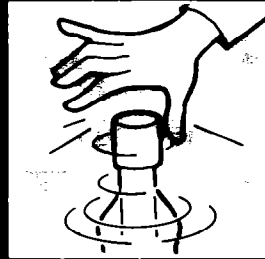

NEVER put your hands into the washer until all motion stops. If the lid is opened while the basket is spinning, the basket will automatically stop in a few seconds.

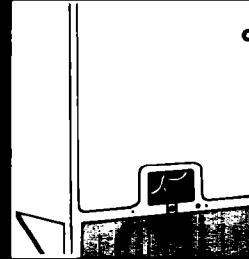

NEVER operate the appliance if ...

- it is not working right,
- it is damaged,
- parts are missing,
- all panels are not in place.

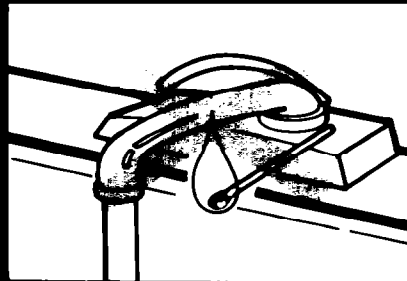

SPECIAL CAUTION: If hot water has not been used recently (usually two weeks or longer), flammable hydrogen gases may build up in the water heater and hot water pipes. To prevent injury or damage, turn on all hot water faucets and allow water to run for several minutes. This will allow gases to escape. Do not smoke or use any open flame near the faucet while it is open.

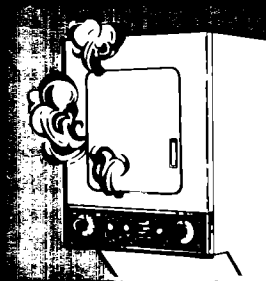

FIRE HAZARD and DAMAGE to some materials can result from:

- drying heat-sensitive fabrics with heat (see page 13).
- operating the dryer with the lint screen loose, damaged or missing.
- allowing lint to build up inside the dryer (see page 15).

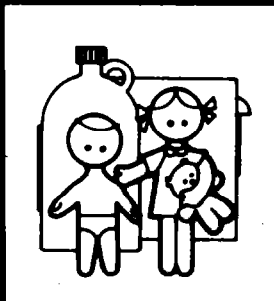

DO NOT allow children to operate or play with the washer.

ALWAYS store detergent, laundry aids and other materials in a cool, dry place where children can't reach them – in a locked cabinet, if possible.

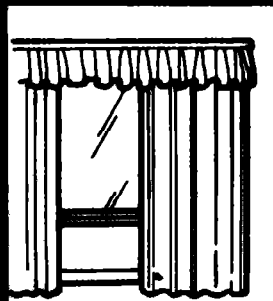

DO NOT machine wash or dry glass fiber materials. Small particles can stick to fabrics washed and dried in following loads and cause skin irritation.

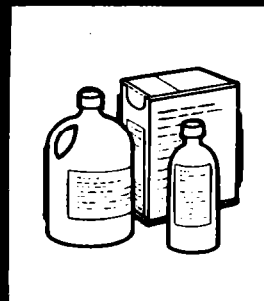

ALWAYS read and follow instructions on packages of detergent and laundry aids – especially warnings and precautions.

• **SAVE THESE INSTRUCTIONS** •

Before using your THIN TWIN* washer • dryer

For best washing and drying results, you must take some very important steps before, during and after each load:

1. Prepare and sort each load for washing ("Laundry Guide," pages 4-5).
2. Measure and add detergent or soap to washer ("Laundry Guide," pages 9-10).
3. Load the washer properly ("Laundry Guide," pages 6-7).
4. Select the water temperature, load size and cycle recommended for the fabrics before starting the washer ("Use and Care Guide," pages 6-7).
5. Add other laundry aids to the washer according to instructions ("Laundry Guide," pages 11-13).
6. Properly sort the load for drying ("Laundry Guide," pages 18-19).
7. Select the right drying cycle and time for the fabrics ("Use and Care Guide," page 13).
8. Remove and hang or fold items **immediately** after drying.

Service or performance problems caused by the use of any product not manufactured by Whirlpool Corporation are the responsibility of the manufacturer of that product.

Starting your washer

Before starting your washer:



1. Measure and add detergent.
2. Place sorted load in washer.
3. Start washer.

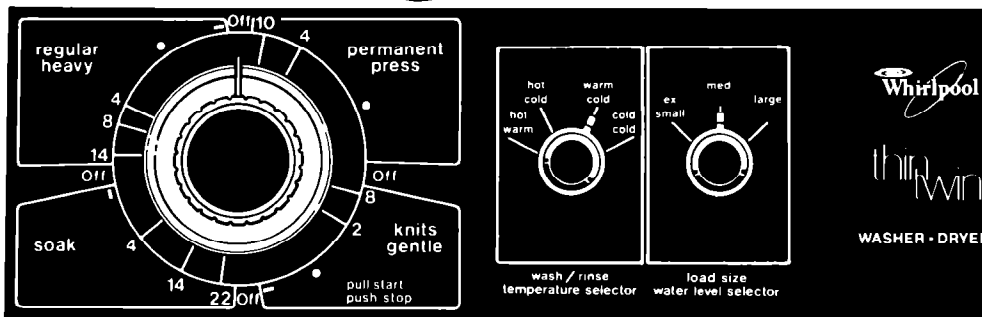

Select a 1. LOAD SIZE

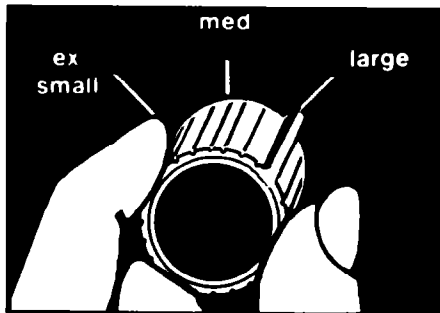

- Turn the knob to point at a setting that describes the size of load you want to wash.
- The water level can be set for EX SMALL, MEDIUM or LARGE loads. Select the water level that matches the load size.

See your "Laundry Guide" for details on load sizes.

Select WATER 2. TEMPERATURES

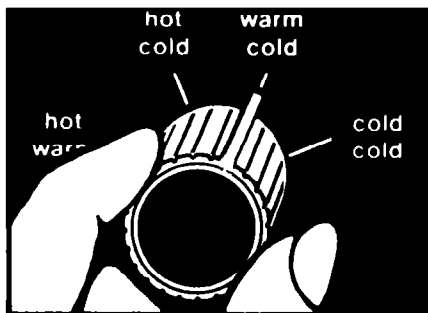

- Match the wash water temperature to the type of fabrics and soils being washed.

Recommended wash temperatures can be found in your "Laundry Guide"

LOAD SIZES AND WATER LEVELS

For best cleaning results, the load must be able to move freely in the water. Too big a load or too little water can cause wear or tearing of load items.



**DO NOT
OVERLOAD WASHER.**

- LARGE**
(11.9 gals. / 45.1 L)*
- MEDIUM**
(9.6 gals. / 36.3 L)*
- EX-SMALL**
(7.3 gals. / 27.7 L)*

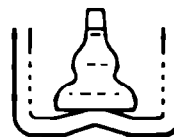

*Approximate fill with load

To hold the washer lid up, lift the lid until it snaps past the latch.

To release the lid, push the lid latch up.

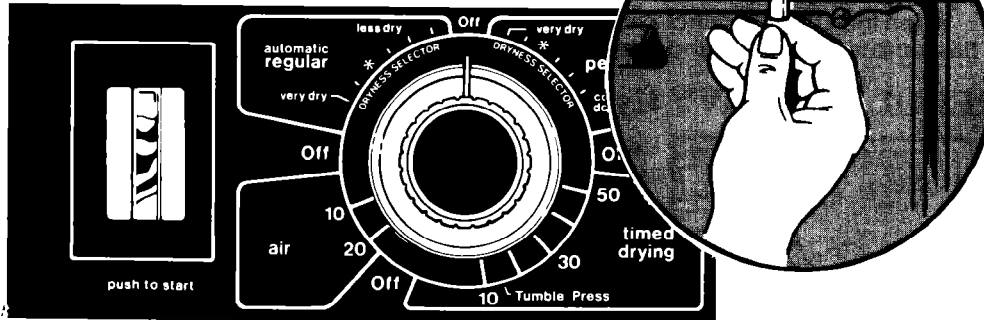

STARTING YOUR WASHER

Select CYCLE and WASH TIME; 3. Start the washer

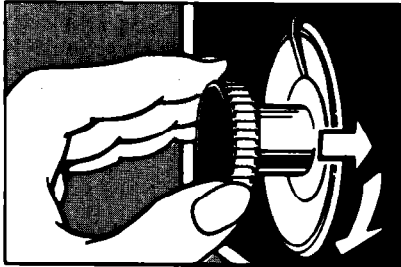

A. Push in the Control Knob and turn it to the right. It must be pushed in and turned only clockwise.

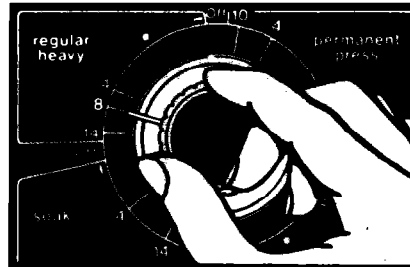

B. Stop on a number in the cycle you want. The numbers are minutes of wash time. The drawing shows 8 minutes of agitation in the REGULAR HEAVY Cycle.

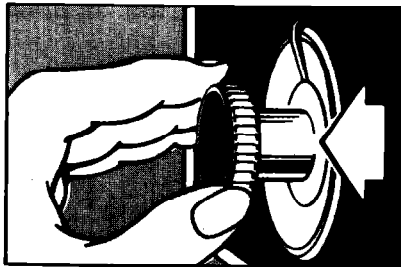

C. Start the washer by pulling out the Control Knob. The washer will fill to the level you set with wash water of the selected temperature. After filling, the washer will agitate for the selected number of minutes.

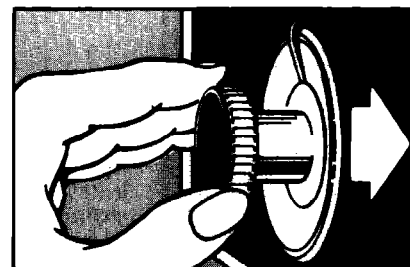

D. To stop the washer at any time, push in the Control Knob. To restart the washer, pull out the Control Knob.

What happens in each cycle

Each cycle has different agitation and spin speeds designed for different kinds of fabrics. Numbers on the dial in each cycle are the minutes of WASH agitation time.

When the Cycle Control Knob is set to a number and pulled out, the washer fills before agitation and timing starts. After agitation starts, the knob turns

REGULAR HEAVY Cycle

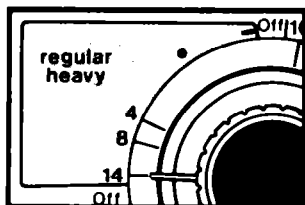

High agitation and spin speeds help remove heavy soils and spin water from heavy or sturdy cotton fabrics.

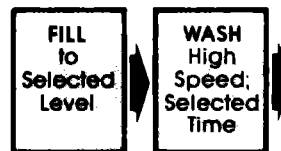

PERMANENT PRESS Cycle

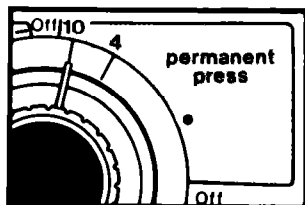

High-speed agitation, low-speed spin and cooling of the wash water before the spin help clean clothing and keep wrinkles from setting into permanent press fabrics.

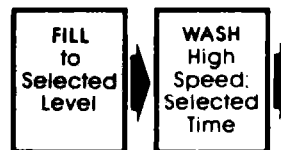

KNITS/GENTLE Cycle

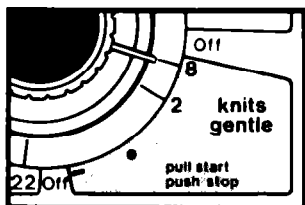

Low agitation and spin speeds and shorter wash time gently wash delicate items and washable synthetic knits.

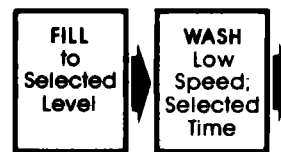

SOAK Cycle

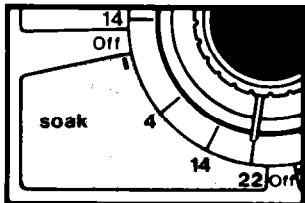

Periods of agitation and soaking time clean stained, yellowed, gray or heavily soiled laundry. Use recommended amount of detergent.

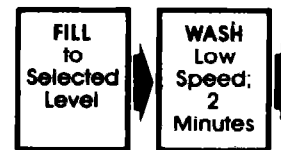

clockwise until it points to OFF and the cycle ends.

NOTE: You may hear the sound of water spraying during the spin parts of some cycles. In some cycles, cold water is sprayed on the spinning load to help with the rinsing.

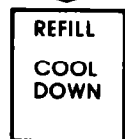
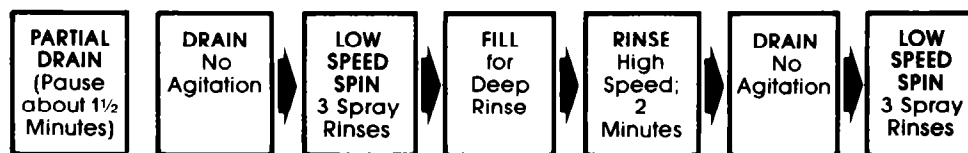
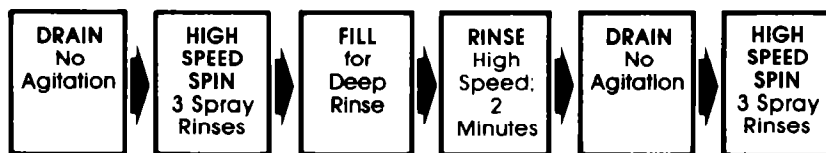

NOTE: Always use **cold rinse water** for permanent press fabrics.

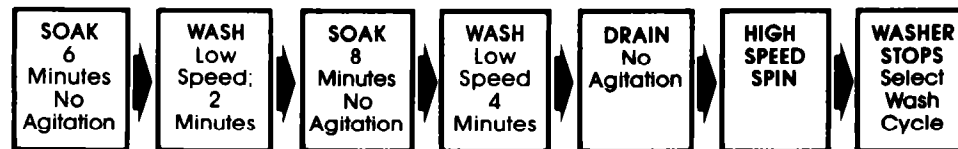
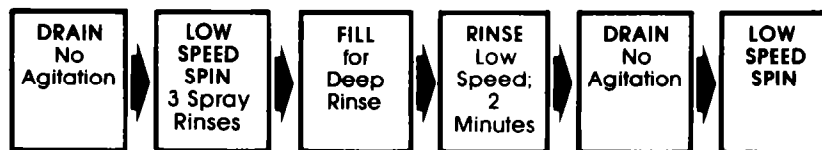

← Pre-wash setting begins here (see page 10)

Special care is needed when soaking or pre-washing laundry. See your "Laundry Guide" for proper use of this cycle.

WHAT HAPPENS IN EACH CYCLE

Other operating instructions

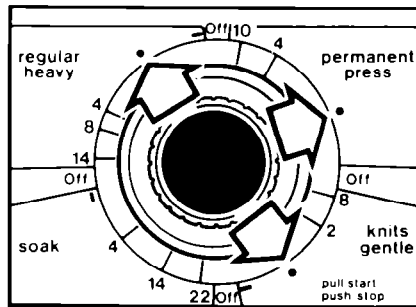

For a rinse and spin

You may need an extra rinse and spin for heavily soiled loads which need more detergent. (Extra detergent can require an extra rinse.)

- Push Control Knob in.
- Turn clockwise to any • on the dial. **See above drawing.**
- Pull Control Knob out.
- The washer will fill to selected level; agitate 2 minutes; drain and spin.

For agitation and spin speeds in each cycle, see pages 8 and 9.

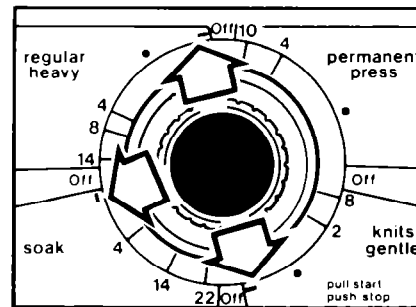

For a drain and spin

Your washer can be set to drain and spin out water.

- Push Control Knob in.
- Turn clockwise to the bar just before OFF. **See above drawing.**
- Pull Control Knob out.
- The washer will drain and spin.

For a soak or pre-wash

For best results, use **warm** water for soaking or pre-washing stained laundry. **Hot water can set stains.**

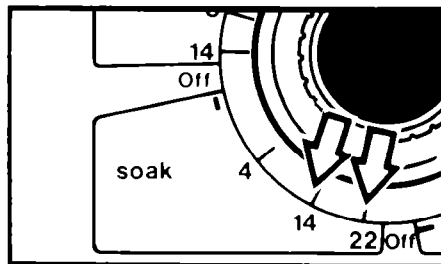

- Use recommended amount of detergent or pre-soak product.
- Push Control Knob in.
- Turn clockwise to point at a **number** in the SOAK Cycle.*
- Pull Control Knob out to start washer.
- When the cycle is over, add detergent for the next selected wash cycle. **The SOAK Cycle should always be followed by a Wash Cycle.**

Important: See additional care information on page 7 of your "Laundry Guide."

*To start soak with agitation, the Cycle Control Knob must point to a number in the SOAK Cycle.

Cleaning the lint filter

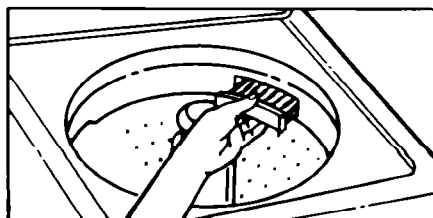

Water runs through the lint filter whenever the washer agitates. Check it often to make sure it's clean and is filtering at its best.

To remove it for cleaning, press the release and pull straight out. Instructions for cleaning are printed on the bottom of the filter.

Starting your dryer

Before starting your dryer, be sure laundry is sorted and loaded properly (see your "Laundry Guide"). **Be sure the door is tightly closed.**

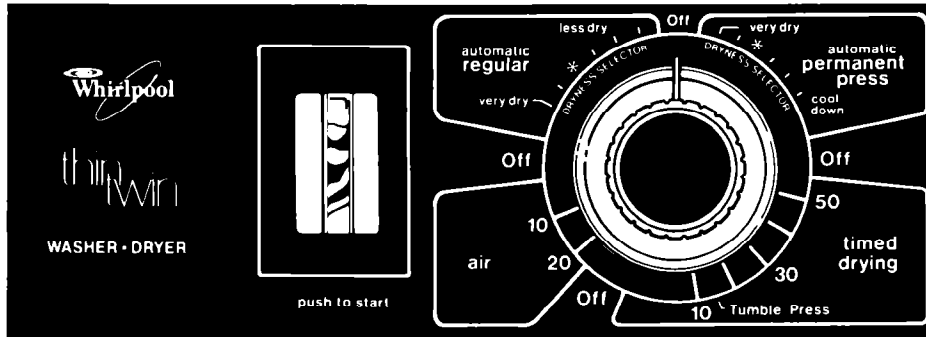

1. Select CYCLE and TIME

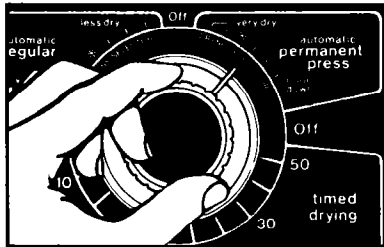

Turn the Control Knob either way to point to the time setting you want in the cycle you want.

2. Push the START Button

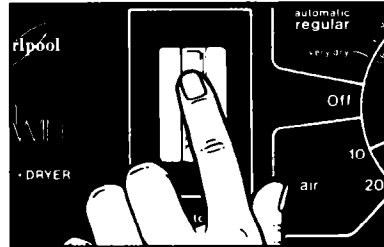

The dryer will start tumbling when you push the START Button.

3. To stop and restart the dryer

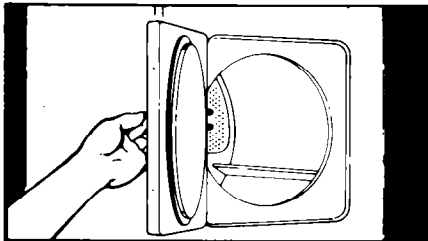

To stop, open the door (or turn the Control Knob to OFF).

To restart, close the door and push the START button.

4. Changing a setting

The setting can be changed at any time by turning the Control Knob to a new setting.

The Cycle Control Knob should point to OFF when the dryer is not in use.

Operating instructions

The automatic cycles

The automatic cycles allow you to select the degree of dryness you prefer for the clothes being dried.

The Control Knob moves and stops several times until the load reaches the dryness setting you selected. Then the knob automatically moves to OFF and tumbling stops.



Use **AUTOMATIC REGULAR** to dry heavy and medium-

weight cotton items. **The load tumbles without heat during the last 5 minutes.** This helps make the load easier to handle.



Use **AUTOMATIC PERMANENT PRESS** to dry permanent

press, knits and other synthetic fabrics. **The load tumbles without heat during the last 10 minutes.** This helps keep wrinkles from setting in.

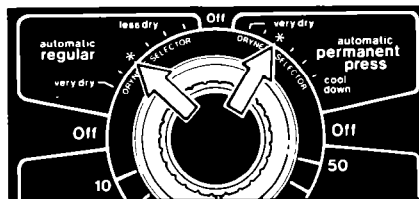

For the first few loads, set the Control Knob to point to an * in either automatic cycle. When the dryer stops, feel the dried items.

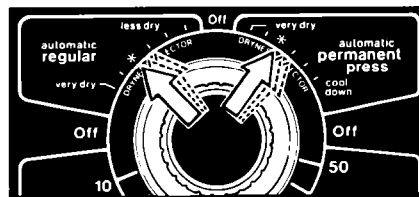

- If items are drier than you like, use a setting to the right of the * the next time you dry a similar load.

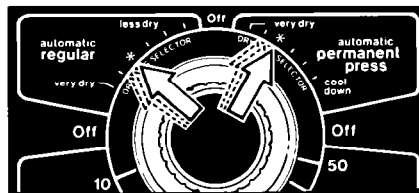

- If items are not as dry as you like, use a setting to the left of the * the next time you dry a similar load.

OVERDRYING CAN CAUSE SHRINKAGE, STATIC CLING AND DAMAGE TO SOME FABRICS.

Timed drying

Use the **TIMED DRYING** Cycles for any load you want to dry by time. For example: small loads, large bulky items, items to be fluffed or dusted.

- Turn the Control Knob to the number of minutes you want – from 10 to 50.
- The last 5 minutes of this cycle are without heat – a cool-down time. This helps make the load easier to handle.

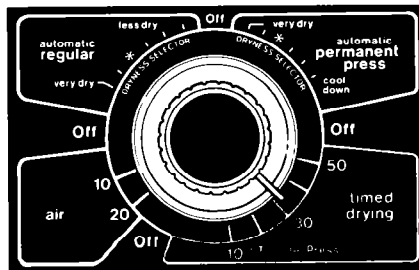

Selecting a cycle

TYPE OF LOAD	SUGGESTED CYCLE
COTTONS – LINENS	
EXTRA HEAVY – Bedspreads, mattress pads, quilts	AUTOMATIC REGULAR
HEAVYWEIGHT FABRICS – Towels, jeans, corduroys, work clothes	
MEDIUMWEIGHT COTTONS – Sheets, pillowcases, cotton underwear, diapers	
LIGHTWEIGHT COTTONS – Batistes, organdies, lingerie	
PERMANENT PRESS, SYNTHETICS AND BLENDS	
HEAVYWEIGHT FABRICS – Work clothes, jackets, raincoats	AUTOMATIC PERMANENT PRESS
MEDIUMWEIGHT FABRICS – Shirts, play clothes, sheets, slacks	
LIGHTWEIGHT FABRICS – Lingerie, blouses, dresses	
KNITS	
HEAVYWEIGHT – Cottons, rayons, blends, T-shirts, slacks, shirts	AUTOMATIC PERMANENT PRESS
LIGHTWEIGHT – Synthetics (polyester, acrylic, etc.) and blends, lingerie, blouses, dresses	
LIGHTWEIGHT AND DELICATE FABRICS	
Sheer Curtains (2 or 3 panels)	AUTOMATIC PERMANENT PRESS
Gauze, lace, etc.	
RUBBER, PLASTIC, HEAT-SENSITIVE FABRICS	
FOAM RUBBER – Pillows, bras, stuffed toys	AIR 20 MINS.
PLASTIC – Shower curtains, tablecloths	20 MINS.
OLEFIN, POLYPROPYLENE, SHEER NYLON	15-20 MINS.

WARNING: Drying these and other heat-sensitive materials with heat can damage them or be a FIRE HAZARD.

Drying tips

AIR Setting

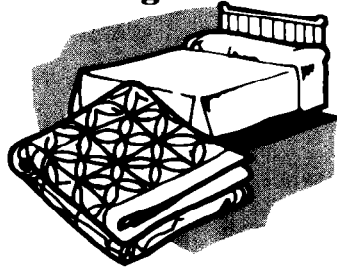

The dryer does not heat when the Control Knob is set on AIR. This setting can be used to fluff bedding, plastic tablecloths, foam rubber pillows, stuffed toys, sneakers, etc.

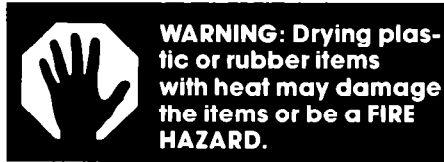

Mixed loads

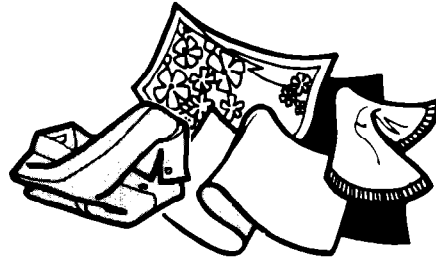

When drying a load with different kinds and weights of fabrics, use the cycle suggested for the lightest fabrics. When the dryer stops, remove dry items and reset the control.

To help reduce wrinkling, take the load from the dryer **as soon as tumbling stops**. This is very important for permanent press, knits and other synthetic fabrics.

TUMBLE PRESS Setting

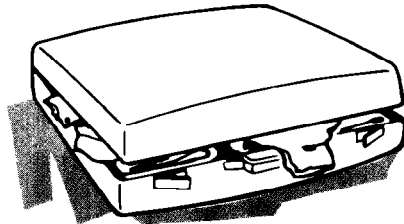

The TUMBLE PRESS setting removes wrinkles from dry clothing such as items that may have been packed in a suitcase, closet, or items not removed from the dryer.

The load will tumble in heated air for 5 minutes. The heat shuts off and the dryer continues to tumble the load for 10 more minutes.

For best results, TUMBLE PRESS only a few items at a time. Put them on hangers or fold them as soon as the dryer stops.

Drying times

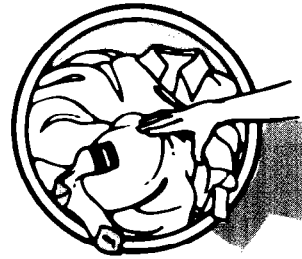

Drying times will vary depending on:

- amount of moisture in the clothes.
- type and weight of the fabric.
- size of the load.
- room temperature around the dryer.
- temperature of the wash rinse water.
- amount of lint in the lint screen.
- dryer temperature selection.

See page 19 in your "Laundry Guide" for more information.

Lint screen

Clean the lint screen before each load. A screen blocked by lint can increase drying time and may be a FIRE HAZARD.

The lint screen is inside the dryer drum, on the back wall. Pull straight out.

1. Use the finger holes to pull the lint screen straight out.

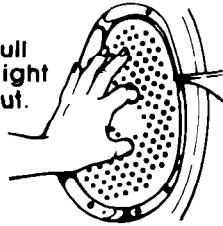

2. Lightly squeeze the body, as shown, while pulling the cover off.

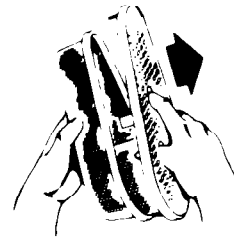

3. Roll lint off the screen with your fingers. **DO NOT rinse or wash the screen. Wet lint is hard to remove.**
4. Replace the cover on the body of the lint screen.
5. Push the lint screen straight back in until it clicks into place.

Squeeze body; pull cover off.



WARNING: DO NOT run the dryer with the lint screen loose, damaged or missing. Doing so can cause overheating, can damage fabrics and can be a **FIRE HAZARD**.

Lint removal

Lint can gather inside the dryer and create a fire hazard. **This lint should be removed every 2 to 3 years, or more often, depending on dryer usage.**

Cleaning should be done only by a qualified service person.

1. Remove back panel from dryer.
2. Avoid touching thermostats, wires, terminals and heater box.
3. Remove lint from shaded area – see art – with a soft brush or vacuum cleaner.
4. Replace back panel. Reconnect, exhaust duct, etc. Level the washer/dryer.



- Avoid electrical shock hazard – unplug power supply cord or turn off electrical power.
- Avoid injury or damage – do not put hands inside cabinet.
- Metal edges may be sharp.
- Make sure dryer is cool.

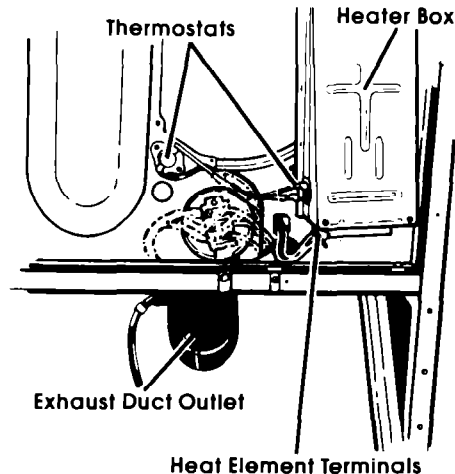

Vacation care

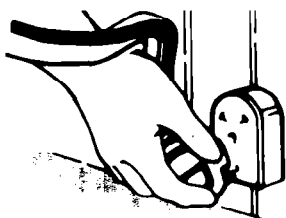

1. Turn off both water faucets to take pressure off inlet valves and hoses.
2. Unplug power supply cord or turn off electrical power supply.
3. Clean lint screen and lint filter.

Winterizing

Install and store your washer / dryer where it won't freeze. Because some water stays in the washer, freezing can damage it. If your washer / dryer is stored **or moved** during freezing weather, winterize it.

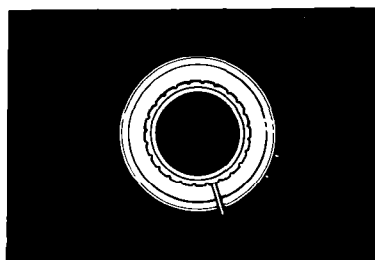
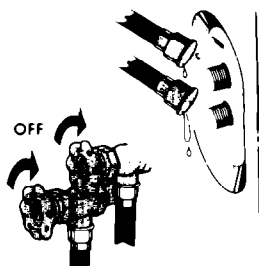

1. Shut off both water faucets. Disconnect and drain water inlet hoses.
2. Put a quart of auto-mobile-type anti-freeze in the basket.
3. Run washer on a drain and spin setting (see page 10) for about 30 seconds to mix antifreeze and water.

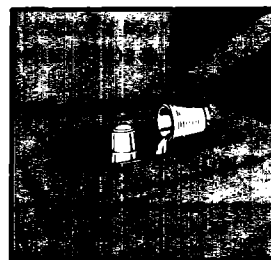
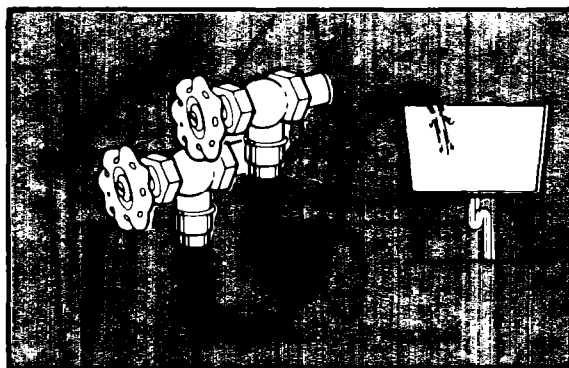

To use the washer again...

1. Flush water pipes and hoses.
2. Reconnect water inlet hoses.
3. Turn on both water faucets.

4. To clean out anti-freeze, run washer through a complete cycle with a cup of detergent.

If you need service or assistance, we suggest you follow these four steps:

1. Before calling for assistance...

Performance problems often result from little things you can find and fix yourself without tools of any kind.

IF YOUR WASHER DOES NOT FILL:

- Is the power supply cord plugged in?
- Are both water faucets open?
- Are fuses blown or circuit-breaker tripped?
- Are the water supply hoses kinked?
- Is the Cycle Control Knob set and pulled out?

IF YOUR WASHER DOES NOT SPIN:

- Is the lid closed?
- Is the power supply cord plugged in?

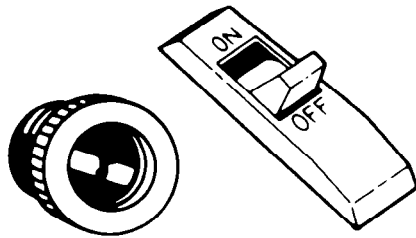

- Are fuses blown or a circuit-breaker tripped?

IF WASHER DRAINS AT THE WRONG TIME:

- The drain hose should be at least 28 inches above the floor and secured.
- The drain hose should not fit tightly in the drain pipe.

MAKE SURE THE DRAIN HOSE IS HIGHER THAN THE WATER LEVEL IN THE WASHER. IF IT ISN'T...

- The washer may seem to be draining during wash and rinse cycles.
- Water can siphon out. (See "Installation Instructions.")

IF YOUR WASHER STOPS DURING THE PERMANENT PRESS CYCLE:

- Remember, the washer will stop for about 1½ minutes after the partial drain during the cool-down period in this cycle.

DRYER DOESN'T RUN OR DOESN'T HEAT:

- Is it plugged in?
- Is the circuit-breaker tripped or one or both of the fuses blown?
- Did you push START?
- Is the door closed?
- The AIR setting is without heat.
- The last minutes of heat settings are without heat. See page 12.

DRYING TIME SEEMS LONG:

- Is the lint screen clean?
- Is the room cold?
- Check your "Laundry Guide," page 19.

2. If you need assistance*...

Call Whirlpool COOL-LINE® service assistance telephone number.

Dial free from:

Continental U.S. . . (800) 253-1301

Michigan (800) 632-2243

Alaska & Hawaii (800) 253-1121

and talk with one of our trained Consultants. The Consultant can instruct you in how to obtain satisfactory operation from your appliance or, if service is necessary, recommend a qualified service company in your area.

3. If you need service*...



Whirlpool has a nationwide network of franchised TECH-CARE® Service Companies. TECH-CARE service technicians are trained to fulfill the product warranty and provide after-warranty service, anywhere in the United States. To locate TECH-CARE service in your area, call our COOL-LINE service assistance telephone number (see Step 2) or look in your telephone directory Yellow Pages under:

APPLIANCES - HOUSEHOLD - MAJOR - SERVICE & REPAIR	OR	ELECTRICAL APPLIANCES - MAJOR - REPAIRING & PARTS
WHIRLPOOL APPLIANCES FRANCHISED TECH-CARE SERVICE		WHIRLPOOL APPLIANCES FRANCHISED TECH-CARE SERVICE
SERVICE COMPANIES		SERVICE COMPANIES
XYZ SERVICE CO 123 Maple 999-9999		XYZ SERVICE CO 123 Maple 999-9999

OR

WASHING MACHINES, DRYERS
& IRONERS - SERVICING

WHIRLPOOL APPLIANCES
FRANCHISED TECH-CARE SERVICE

SERVICE COMPANIES
XYZ SERVICE CO
123 Maple 999-9999

4. If you have a problem*...

Call our COOL-LINE service assistance telephone number (see Step 2) and talk with one of our Consultants, or if you prefer, write to:

Mr. Robert F. Gunts, Vice President
Whirlpool Corporation
Administrative Center
2000 US-33, North
Benton Harbor, MI 49022

*If you must call or write, please provide: model number, serial number, date of purchase, and a complete description of the problem. This information is needed in order to better respond to your request for assistance.



FSP is a registered trademark of Whirlpool Corporation for quality parts. Look for this symbol of quality whenever you need a replacement part for your Whirlpool appliance. FSP replacement parts

will fit right and work right, because they are made to the same exacting specifications used to build every new Whirlpool appliance.



Making your world a little easier.

Part No. 693012 Rev. A.
©1984 Whirlpool Corporation

Printed in U.S.A.

Automatic Washers, Clothes Dryers, Freezers, Refrigerator-Freezers, Ice Makers, Dishwashers, Built-In Ovens and Surface Units, Ranges, Micr

